

Price List

Scandinavia

1st Half / 2025



BRDR. KRÜGER

DANISH CRAFT AND DESIGN

1886

Index

Tables	Bølling Collection , Hans Bølling	4-14
	HB Coffee Table , Hans Bølling	15
	Jari Low Collection , OEO Studio	17-23
	Orbis Table , O&M Design	24
	Jari Dining Table , OEO Studio	25-27
	Arv Dining Table , David Thulstrup	28-31
	TRIIIO Collection , Hans Bølling	32-35
Seating	Ekko Chair , Henning Larsen Architects	37-38
	HB Lounge Chair , Hans Bølling	39-41
	Arv Dining Chair , David Thulstrup	42-44
	Arv Lounge Chair , David Thulstrup	45
	Arkade Chair , Nanna Ditzel	47-48
	F-Chair , Rasmus B. Fex	49-53
	Pauline Bar Stool , OEO Studio	54-65
	Jari Dining Chair , OEO Studio	66-67
	Ferdinand Lounge Chair , OEO Studio	68-69
	Karm Sofa , Studio David Thulstrup	70-73
Lighting	Lune Collection , Sverre Uhnger	74-76
Complements	Samples	79
General Information	Sustainability	81
	Material Information	82-89
	Terms & Conditions	91-96

Tables







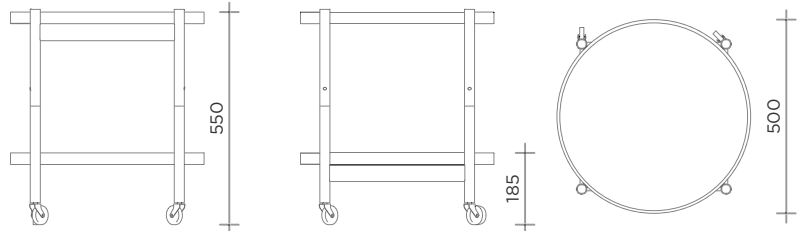

Bølling Tray Table

by Hans Bølling

Bølling Tray Table - Model 50
Hans Bølling



		EURO ex. VAT	#Reference
	Beech, Untreated / Out of collection in June 2025	610	BBO1-BUN
	Beech, Oiled	700	BBO1-BOL
	Oak, Untreated / Out of collection in June 2025	720	BBO1-OUN
	Oak, Oiled	810	BBO1-OOL
	Oak, Black Lacquer / Out of collection in June 2025	1.080	BBO1-OBA
	Fumed Oak, Oiled	900	BBO1-OFU
	Walnut, Oiled	1.080	BBO1-WOL







Tray Colour	# Reference
	BASE (Black / White) BA
	STONE (Grey / Dark Grey) ST
	EARTH (Beige / Brown) EA
	LEAF (Green / Dark Green) LE
	WATER (Blue / Dark Blue) WA
	SUNNY (Cream / Yellow) SU
	CLAY (Cognac / Black) CL
	RED (Red / Black) RE









Dimensions	
Diameter	Ø500 mm
Height	550 mm
Tray Height	30 mm
Box	790 x 130 x 580 mm
Weight	4,5 kg

Notes:

- Shipped flat packed.
- Ready to assemble, no tools needed.
- Top and bottom trays come in the same colour combination as standard.
- Handling cost of choosing two different colour combinations is 65 Euro net, ex. VAT







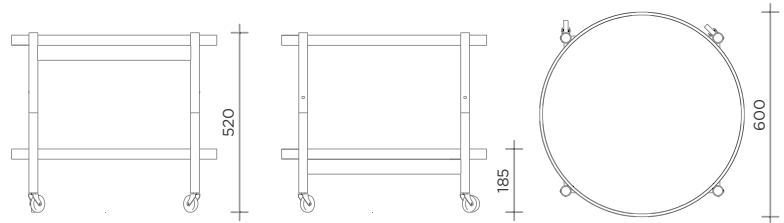

		EURO ex. VAT	#Reference
	Beech, Untreated / Out of collection in June 2025	200	BBB1-BUN
	Beech, Oiled	230	BBB1-BOL
	Oak, Untreated / Out of collection in June 2025	240	BBB1-OUN
	Oak, Oiled	270	BBB1-OOL
	Oak, Black Lacquer / Out of collection in June 2025	360	BBB1-OBA
	Fumed Oak, Oiled	300	BBB1-OFU
	Walnut, Oiled	360	BBB1-WOL

Tray Colour	# Reference	Dimensions
 BASE (Black / White)	BA	Diameter Ø500 mm
 STONE (Grey / Dark Grey)	ST	Height 30 mm
 EARTH (Beige / Brown)	EA	Box 520 x 520 x 40 mm
 LEAF (Green / Dark Green)	LE	Weight 2 kg
 WATER (Blue / Dark Blue)	WA	
 SUNNY (Cream / Yellow)	SU	
 CLAY (Cognac / Black)	CL	
 RED (Red / Black)	RE	

Bølling Tray Table - Model 60
Hans Bølling



		EURO ex. VAT	#Reference
	Beech, Untreated / Out of collection in June 2025	730	BBO3-BUN
	Beech, Oiled	820	BBO3-BOL
	Oak, Untreated / Out of collection in June 2025	860	BBO3-OUN
	Oak, Oiled	960	BBO3-OOL
	Oak, Black Lacquer / Out of collection in June 2025	1.300	BBO3-OBA
	Fumed Oak, Oiled	1.110	BBO3-OFU
	Walnut, Oiled	1.300	BBO3-WOL

Tray Colour	# Reference
	BASE (Black / White) BA
	STONE (Grey / Dark Grey) ST
	EARTH (Beige / Brown) EA
	LEAF (Green / Dark Green) LE
	WATER (Blue / Dark Blue) WA
	SUNNY (Cream / Yellow) SU
	CLAY (Cognac / Black) CL
	RED (Red / Black) RE







Dimensions	
Diameter	Ø600 mm
Height	520 mm
Tray Height	25 mm
Box	900 x 120 x 650 mm
Weight	5,5 kg









Notes:

- Shipped flat packed.
- Ready to assemble, no tools needed.
- Top and bottom trays come in the same colour combination as standard.
- Handling cost of choosing two different colour combinations is 65 Euro net, ex. VAT

Bølling Serving Tray - Model 60
Hans Bølling



		EURO ex. VAT	#Reference
	Beech, Untreated / Out of collection in June 2025	240	BBB2-BUN
	Beech, Oiled	270	BBB2-BOL
	Oak, Untreated / Out of collection in June 2025	290	BBB2-OUN
	Oak, Oiled	320	BBB2-OOL
	Oak, Black Lacquer / Out of collection in June 2025	430	BBB2-OBA
	Fumed Oak, Oiled	370	BBB2-OFU
	Walnut, Oiled	430	BBB2-WOL

Tray Colour		# Reference	Dimensions	
	BASE (Black / White)	BA	Diameter	Ø600 mm
	STONE (Grey / Dark Grey)	ST	Height	25 mm
	EARTH (Beige / Brown)	EA	Box	620 x 620 x 40 mm
	LEAF (Green / Dark Green)	LE	Weight	2,5 kg
	WATER (Blue / Dark Blue)	WA		
	SUNNY (Cream / Yellow)	SU		
	CLAY (Cognac / Black)	CL		
	RED (Red / Black)	RE		





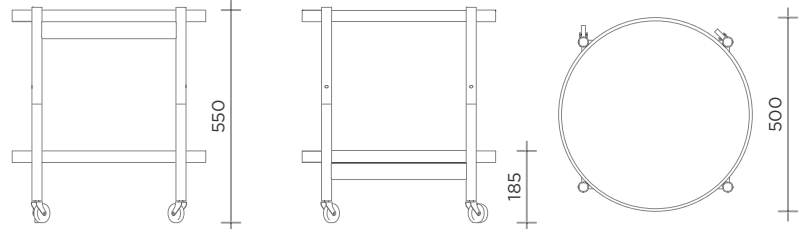

Bølling Veneer Tray Table

by Hans Bølling

Bølling Tray Table - Veneer Model 50
Hans Bølling



		EURO ex. VAT	#Reference
	Beech, Oiled	790	BBO1-BOL-VV
	Oak, Oiled	900	BBO1-OOL-VV
	Oak, Black Lacquer / Out of collection in June 2025	1.170	BBO1-OBA-VV
	Fumed Oak, Oiled	990	BBO1-OFU-VV
	Walnut, Oiled	1.170	BBO1-WOL-VV

Dimensions





Diameter	Ø500 mm
Height	550 mm
Tray Height	30 mm
Box	790 x 130 x 580 mm
Weight	4,5 kg

Notes:

- Shipped flat packed.
- Ready to assemble, no tools needed.
- Both sides of the trays are made of veneer.
- Handling cost of choosing two different colour combinations is 65 Euro net, ex. VAT

Bølling Serving Tray - Veneer Model 50
Hans Bølling







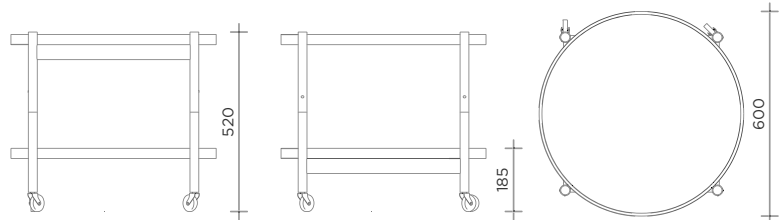

		EURO ex. VAT	#Reference
	Beech, Oiled	260	BBB1-BOL-VV
	Oak, Oiled	300	BBB1-OOL-VV
	Oak, Black Lacquer / Out of collection in June 2025	390	BBB1-OBA-VV
	Fumed Oak, Oiled	330	BBB1-OFU-VV
	Walnut, Oiled	390	BBB1-WOL-VV

Dimensions

Diameter	Ø500 mm
Height	30 mm
Box	520 x 520 x 40 mm
Weight	2 kg

Bølling Tray Table - Veneer Model 60
Hans Bølling



		EURO ex. VAT	#Reference
	Beech, Oiled	940	BBO3-BOL-VV
	Oak, Oiled	1.080	BBO3-OOL-VV
	Oak, Black Lacquer / Out of collection in June 2025	1.420	BBO3-OBA-VV
	Fumed Oak, Oiled	1.230	BBO3-OFU-VV
	Walnut, Oiled	1.420	BBO3-WOL-VV

Dimensions





Diameter	Ø600 mm
Height	520 mm
Tray Height	25 mm
Box	900 x 120 x 650 mm
Weight	5,5 kg

Notes:

- Shipped flat packed.
- Ready to assemble, no tools needed.
- Both sides of the trays are made of veneer.
- Handling cost of choosing two different colour combinations is 65 Euro. net, ex. VAT

Bølling Serving Tray - Veneer Model 60
Hans Bølling



		EURO ex. VAT	#Reference
	Beech, Oiled	310	BBB2-BOL-VV
	Oak, Oiled	360	BBB2-OOL-VV
	Oak, Black Lacquer / Out of collection in June 2025	470	BBB2-OBA-VV
	Fumed Oak, Oiled	410	BBB2-OFU-VV
	Walnut, Oiled	470	BBB2-WOL-VV

Dimensions

Diameter	Ø600 mm
Height	25 mm
Box	620 x 620 x 40 mm
Weight	2,5 kg



	EURO ex. VAT	#Reference
Wheel Set for Bølling Tray Table	50	BBhjul

Note:

Set with 4 wheels.





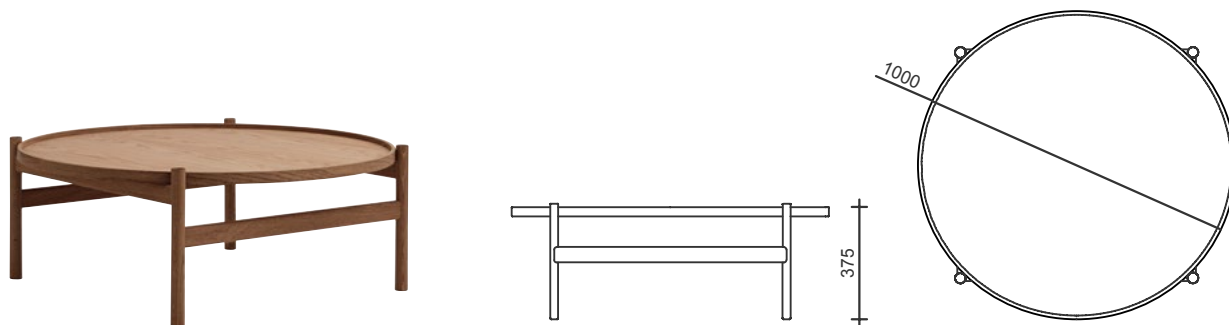

HB Coffee Table

by Hans Bølling

HB Coffee Table
Hans Bølling



		EURO ex. VAT	#Reference
	Oak, Oiled	1.580	BO09-OOL
	Fumed Oak, Oiled	1.760	BO09-OFU
	Maple, White Oiled / Out of collection in June 2025	1.580	BO09-MWO
	Cherry, Oiled / Out of collection in June 2025	1.760	BO09-COL

Dimensions

Diameter	Ø1000 mm
Height	375 mm
Tray Height	30 mm
Box	1020 x 1020 x 380 mm
Weight	12 kg



Jari Table Collection

by OEO Studio

Jari Side Table - Model C45
OEO Studio

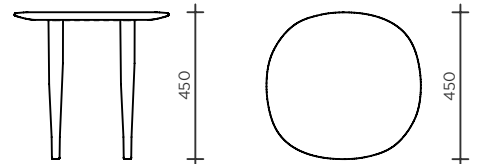

	EURO ex. VAT	#Reference
 Oak, Oiled	1.160	JAJ1-OOL
 Fumed Oak, Oiled	1.250	JAJ1-OFU

Notes:

- Shipped flat packed.
- Ready to assemble, no tools needed.
- Fumed colors will vary across the table.
Read more under material information.

Dimensions

Diameter	Ø450 mm
Height	450 mm
Table Top Thickness	25 mm
Box (top)	470 x 470 x 40 mm
Box (legs)	470 x 160 x 110 mm
Weight	5 kg

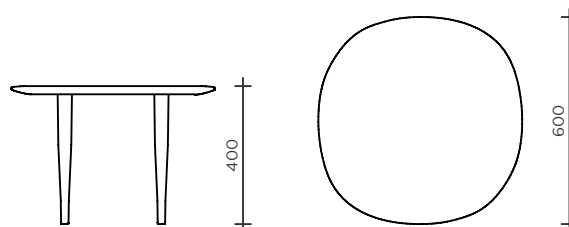

	EURO ex. VAT	#Reference
 Oak, Oiled	1.310	JAJ2-OOL
 Fumed Oak, Oiled	1.400	JAJ2-OFU

Notes:

- Shipped flat packed.
- Ready to assemble, no tools needed.
- Fumed colors will vary accross the table.
Read more under material information.

Dimensions

Diameter	Ø600 mm
Height	400 mm
Table Top Thickness	25 mm
Box (top)	630 x 630 x 40 mm
Box (legs)	470 x 160 x 110 mm
Weight	8 kg

Jari Coffee Table Round - Model C85

OEO Studio

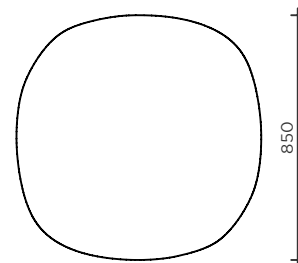
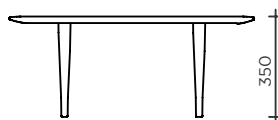

	EURO ex. VAT	#Reference
 Oak, Oiled	1.530	JAJ3-OOL
 Fumed Oak, Oiled	1.620	JAJ3-OFU

Notes:

- Shipped flat packed.
- Ready to assemble, no tools needed.
- Fumed colors will vary across the table.
Read more under material information.

Dimensions

Diameter	Ø850 mm
Height	350 mm
Table Top Thickness	25 mm
Box (top)	930 x 930 x 40 mm
Box (legs)	370 x 160 x 110 mm
Weight	15 kg

Jari Coffee Table Round - Model C118
OEO Studio



	EURO ex. VAT	#Reference
 Oak, Oiled	2.450	JAJ4-OOL
 Fumed Oak, Oiled	2.660	JAJ4-OFU

Notes:

- Shipped flat packed.
- Ready to assemble, no tools needed.
- Fumed colors will vary accross the table.
Read more under material information.

Dimensions

Diameter	Ø1180 mm
Height	250 mm
Table Top Thickness	25 mm
Box (top)	1250 x 1250 x 40
Box (legs)	370 x 160 x 110 mm
Weight	18 kg

Jari Ellipse Coffee Table - Model E130
 OEO Studio

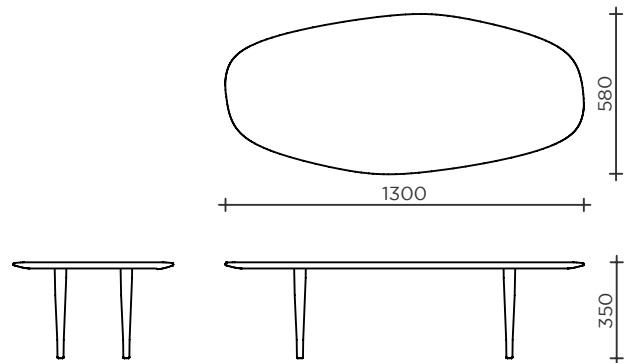

	EURO ex. VAT	#Reference
 Oak, Oiled	2.300	JAJ5-OOL
 Fumed Oak, Oiled	2.500	JAJ5-OFU

Notes:

- Shipped flat packed.
- Ready to assemble, no tools needed.
- Fumed colors will vary accross the table.
 Read more under material information.

Dimensions

Length	1300 mm
Width	580 mm
Height	350 mm
Table Top Thickness	25 mm
Box (top)	1330 x 610 x 40 mm
Box (legs)	370 x 160 x 110 mm
Weight	18 kg

Jari Ellipse Coffee Table - Model E180
OEO Studio



	EURO ex. VAT	#Reference
 Oak, Oiled	2.970	JAJ6-OOL
 Fumed Oak, Oiled	3.410	JAJ6-OFU

Notes:

- Shipped flat packed.
- Ready to assemble, no tools needed.
- Fumed colors will vary accross the table.
Read more under material information.

Dimensions

Length	1800 mm
Width	800 mm
Height	250 mm
Table Top Thickness	25 mm
Box (top)	1830 x 830 x 40
Box (legs)	370 x 160 x 110 mm
Weight	25 kg

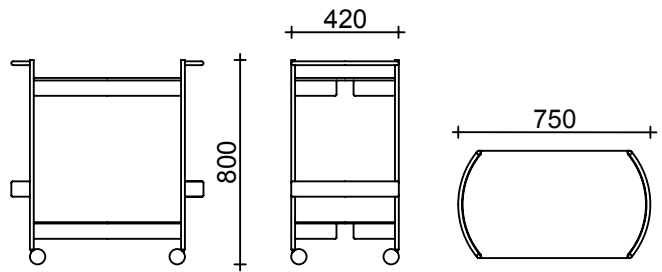

	EURO ex. VAT	#Reference
Stainless Steel, Tempered Glass	2.420	OMS2-CG

Notes:

- Shipped flat packed.
- Must be assembled, tools are included.
- Loose trays.

Dimensions

Length	750 mm
Width	420 mm
Height	800 mm
Box	820 x 500 x 160 mm
Weight	25 kg



Jari Dining Table

by OEO Studio

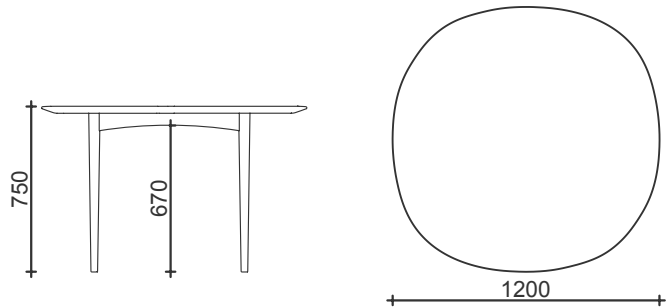

	EURO ex. VAT	#Reference
 Oak, Oiled	3.990	JAO6-OOL
 Fumed Oak, Oiled	4.470	JA06-OFU

Notes:

- Approved for hotel / restaurant (EN 15372: 2016, Test level 2 General)
- Fumed colors will vary across the table. Read more under material information.
- Shipped knock down.

Dimensions

Diameter	Ø1200 mm
Height	750 mm
Solid Wood Table Top Thickness	30 mm
Box	1240 x 1240 x 140 mm
Weight	60 kg

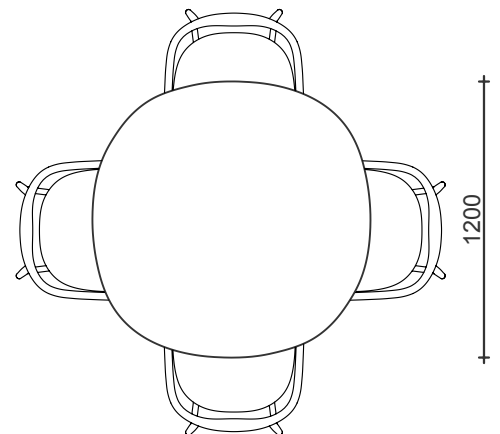

Jari Ellipse Dining Table - Model E240
OEO Studio

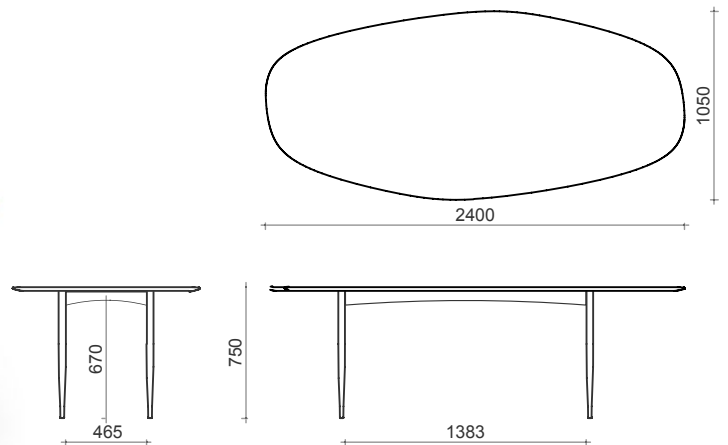

	EURO ex. VAT	#Reference
 Oak, Oiled	6.200	JAT3-OOL
 Fumed Oak, Oiled	7.090	JAT3-OFU

Notes:

- Approved for hotel / restaurant (EN 15372: 2016, Test level 2 General)
- Fumed colors will vary across the table. Read more under material information.
- Shipped knock down.

Dimensions

Length	2400 mm
Width	1050 mm
Height	750 mm
Solid Wood Table Top Thickness	30 mm
Box	2450 x 1100 x 140 mm
Weight	80 kg

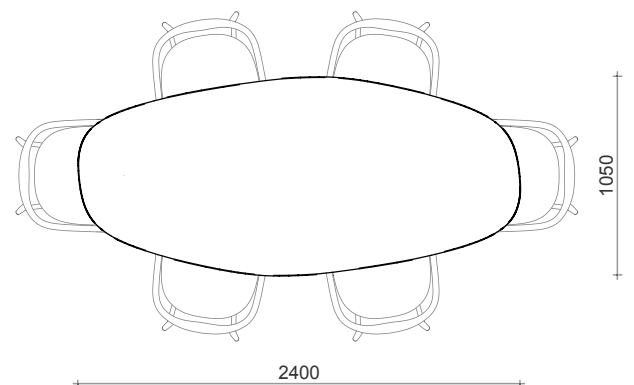



Arv Dining Table

by David Thulstrup

ARV Dining Table - Ø 120 cm
David Thulstrup

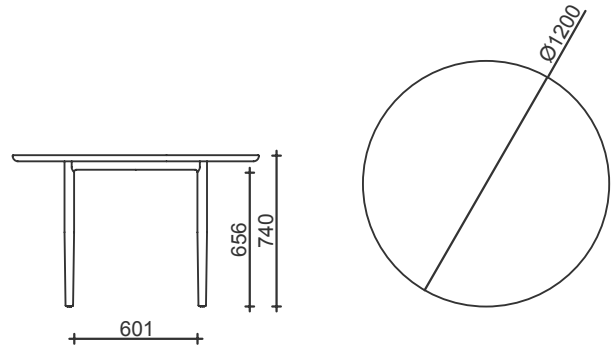

	EURO ex. VAT	#Reference
Oak, White Oiled	4.910	AVO6-OWO
Oak, Oiled	4.910	AVO6-OOL
Fumed Oak, Oiled	5.400	AVO6-OFU
<hr/>		
120 Wooden Expo Box	220	BOX120

Notes:



- Approved for hotel / restaurant (EN 15372: 2016, Test level 2 General)
- Fumed colors will vary across the table. Read more under material information.
- Shipped assembled.
- When making purchases outside Denmark, using the expo box is required unless the client prefers to pick up the items themselves.
- Contact Brdr. Krüger for custom sizes.

Dimensions

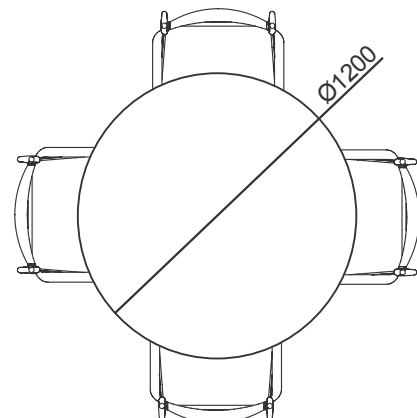
Diameter	Ø1200 mm
Height	740 mm
Solid Oak Table Top Thickness	260 mm
Export Box	1230 x 1230 x 930 mm
Weight (including box)	75 kg

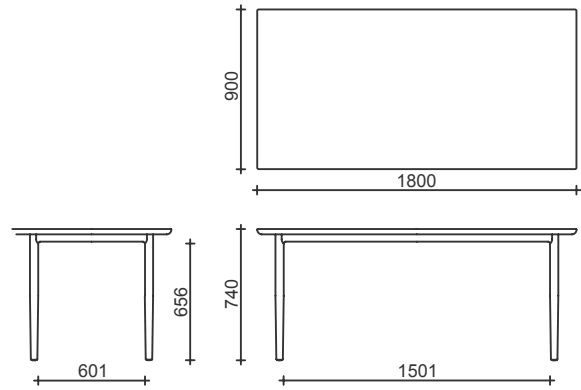



	EURO ex. VAT	#Reference
 Oak, White Oiled	6.310	AVT1-OWO
 Oak, Oiled	6.310	AVT1-OOL
 Fumed Oak, Oiled	6.960	AVT1-OFU
<hr/>		
180 Wooden Expo Box	260	BOX180

Notes:

- Approved for hotel / restaurant (EN 15372: 2016, Test level 2 General)
- Fumed colors will vary across the table. Read more under material information.
- Shipped assembled.
- When making purchases outside Denmark, using the expo box is required unless the client prefers to pick up the items themselves.
- Contact Brdr. Krüger for custom sizes.

Dimensions

Length	1800 mm
Width	900 mm
Height	740 mm
Solid Oak Table Top Thickness	26 mm
Export Box	1830 x 930 x 93 mm
Weight (including box)	100 kg

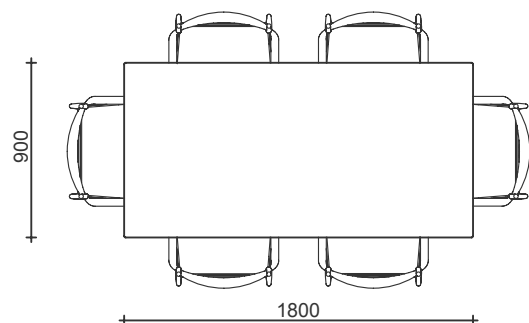

ARV Dining Table - 90x240 cm
David Thulstrup

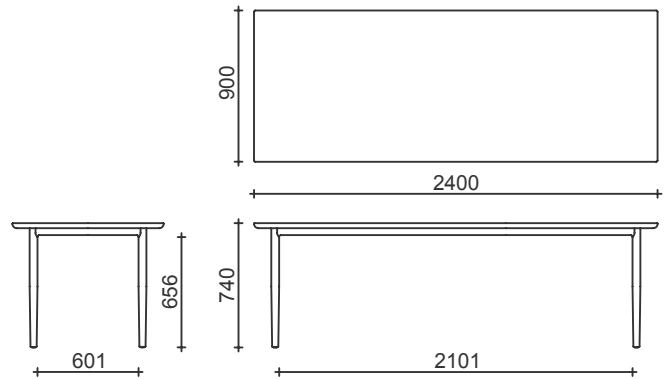

	EURO ex. VAT	#Reference
 Oak, White Oiled	7.130	AVT2-OWO
 Oak, Oiled	7.130	AVT2-OOL
 Fumed Oak, Oiled	8.020	AVT2-OFU
<hr/>		
240 Wooden Expo Box	360	BOX240

Notes:

- Approved for hotel / restaurant (EN 15372: 2016, Test level 2 General)
- Fumed colors will vary across the table. Read more under material information.
- Shipped assembled.
- When making purchases outside Denmark, using the expo box is required unless the client prefers to pick up the items themselves.
- Contact Brdr. Krüger for custom sizes.

Dimensions

Length	2400 mm
Width	900 mm
Height	740 mm
Solid Oak Table Top Thickness	26 mm
Export Box	2430 x 930 x 930 mm
Weight (including box)	125 kg

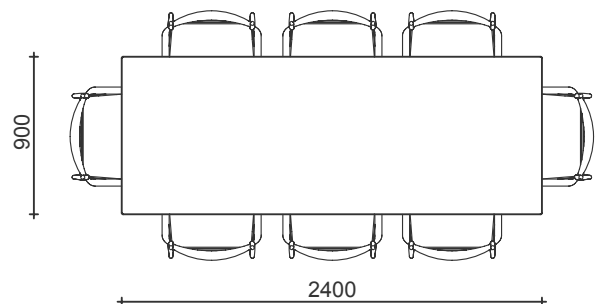





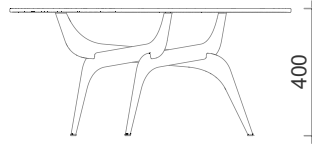

TRIIIIO Table Collection

by Hans Bølling

TRIII Coffee Table
Hans Bølling



	EURO ex. VAT	#Reference
 Oak, Oiled	1.570	TRO5-OOL
 Fumed Oak, Oiled	1.790	TRO5-OFU
 Walnut, Oiled / Out of collection in June 2025	2.360	TRO5-WOL

Glass Colour	# Reference
 Clear	CG
 Bronze	BG



Dimension	
Diameter	Ø900 mm
Height	410 mm
Hardened Glass Thickness	10 mm
Box (glass)	935 x 935 x 60 mm
Box (legs)	810 x 260 x 70 mm
Total Weight	18 kg

Notes:

- Shipped flat packed.
- Ready to assemble, no tools needed.
- Fumed colors will vary accross the table.
Read more under material information.

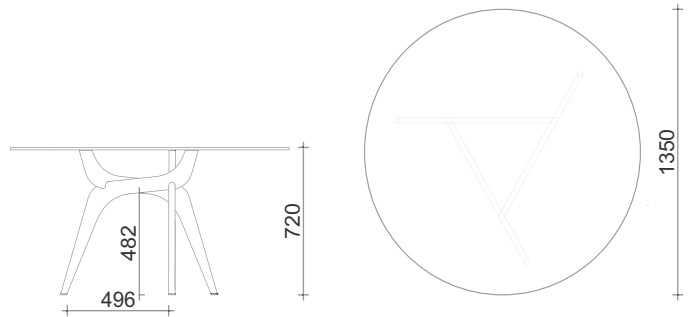
TRIIIØ Dining Table - Ø135 cm
Hans Bølling



	EURO ex. VAT	#Reference
 Oak, Oiled	4.230	TRO7-OOL
 Fumed Oak, Oiled	4.520	TRO7-OFU
 Walnut, Oiled / Out of collection in June 2025	6.340	TRO7-WOL

Glass Colour	# Reference
 Clear	CG
 Bronze	BG

Dimensions	
Diameter	Ø1350 mm
Height	720 mm
Hardened Glass Thickness	10 mm
Box (glass)	1360 x 1360 x 35 mm
Box (legs)	860 x 860 x 800 mm
Total Weight	55,5 kg

Notes:

- Shipped flat packed.
- Ready to assemble, no tools needed.
- Fumed colors will vary accross the table.
Read more under material information.

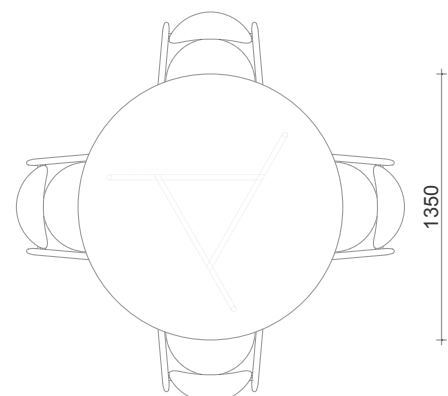

TRIIIIO Dining Table - Solid Table Top Ø120 cm
Hans Bølling

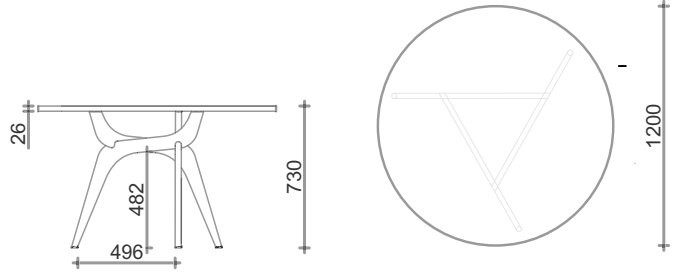

	EURO ex. VAT	#Reference
 Oak, Oiled	4.230	TRO6-OOL-OT
 Fumed Oak, Oiled	4.520	TRO6-OFU-OT

Notes:

- Shipped assembled.
- If requested, shipped flat pack.
- Ready to assemble, no tools needed.
- Fumed colors will vary accross the table.
Read more under material information.

Dimensions

Diameter	Ø1200 mm
Height	730 mm
Solid Oak Table Top Thickness	26 mm
Box (top)	1220 x 1220 x 50 mm
Box (legs)	860 x 860 x 800 mm
Total Weight	54 kg

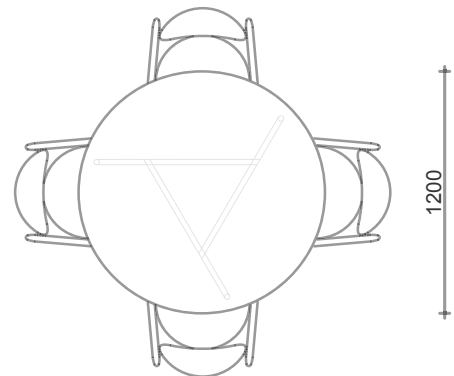

Seating



Ekko Chair

by Henning Larsen Architects

Ekko Chair
Henning Larsen Architects

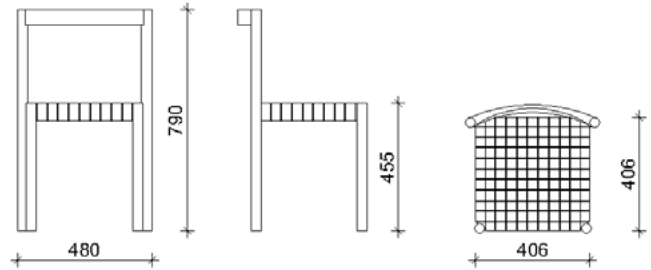

	EURO ex. VAT	#Reference
 Oak, Oiled	880	EKCX-OOL-07
 Fumed Oak, Oiled	940	EKCX-OFU-07

Notes:

- EN 16139: Extreme use: E.g. in night-clubs, police stations, transport, terminals, sport changing rooms, prisons, barracks

Dimensions

Height	790 mm
Seat Width	406 mm
Seat Depth	406 mm
Box	490 x 490 x 800 mm
Weight	6 kg







HB Lounge Chair

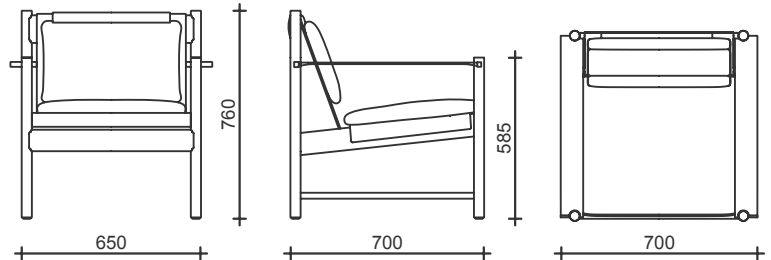

by Hans Bølling

HB Lounge Chair
Hans Bølling



	Canvas frame / Canvas seat and backrest cushion	EURO ex. VAT	#Reference
	Oak, Oiled	2.550	BOCL-OOL
	Fumed Oak, Oiled	2.730	BOCL-OFU
	Maple, White Oiled / Out of collection in June 2025	2.550	BOCL-MWO
	Cherry, Oiled / Out of collection in June 2025	2.730	BOCL-COL

	Canvas frame / Leather seat and backrest cushion	EURO ex. VAT	#Reference
	Oak, Oiled	2.990	BOCL-OOL
	Fumed Oak, Oiled	3.170	BOCL-OFU
	Maple, White Oiled / Out of collection in June 2025	2.990	BOCL-MWO
	Cherry, Oiled / Out of collection in June 2025	3.170	BOCL-COL





Upholstery	# Reference
	Canvas 06
	Spectrum, Brandy Leather - 30155 66

Notes:

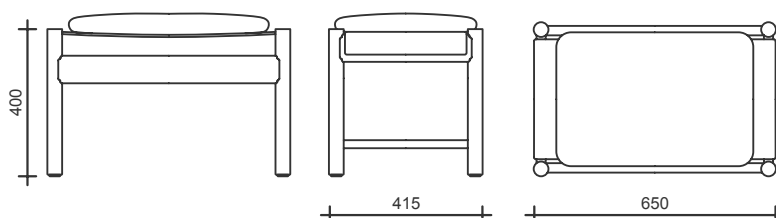
- The COM option for cushions adds 200 Euro plus material to the net price.

Dimensions	
Height	760 mm
Width	700 mm
Seat Depth	536 mm
Seat Height	566 mm
Box	740 x 720mx 800 mm
Weight	15 kg



	Canvas frame	EURO ex. VAT	#Reference
	Oak, Oiled	650	B040-OOL
	Fumed Oak, Oiled	830	BO40-OFU
	Maple, White Oiled / Out of collection in June 2025	650	BO40-MWO
	Cherry, Oiled / Out of collection in June 2025	830	BO40-COL

Cushion

HB Stool Cushion - Canvas Textile	150	BOCC-06
HB Stool Cushion - Spectrum, Brandy Leather	290	BOCC-66

Notes:

- The COM option for cushions adds 135 Euro plus material to the net price.

Dimensions

Height	400 mm
Length	650 mm
Width	415 mm
Box	670 x 460 x 430 mm
Weight	4 kg



Arv Chair

by David Thulstrup

Arv Dining Chair
David Thulstrup

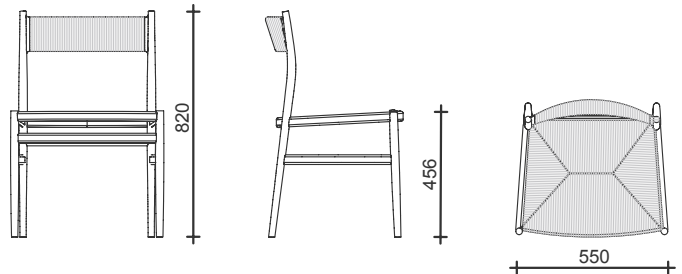

Weaved Seat, Weaved Back

EURO ex. VAT

#Reference

	Oak, White Oiled	1.300	AVCX-OWO-02
	Oak, Oiled	1.300	AVCX-OOL-02
	Fumed Oak, Oiled	1.460	AVCX-OFU-02

Weaved Seat, Solid Back

	Oak, White Oiled	1.300	AVCX-OWO-01
	Oak, Oiled	1.300	AVCX-OOL-01
	Fumed Oak, Oiled	1.460	AVCX-OFU-01

Notes:

- The COM option for seat adds 200 Euro plus material to the net price.
- Approved EN 16139 for extreme use.
- Felt gliders.
- Fumed colors will vary across the chair as the wood content of tanin will vary.
Read more under material information.

Dimensions

Height	820 mm
Width	550 mm
Seat Height	460 mm
Seat Depth	450 mm
Box	630 x 590 x 900 mm
Weight	7 kg

ARV Dining Chair with Armrest
David Thulstrup

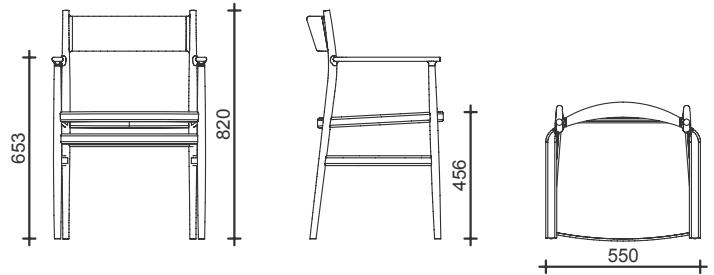

Weaved Seat, Weaved Back

EURO ex. VAT

#Reference

	Oak, White Oiled	1.590	AVCA-OWO-02
	Oak, Oiled	1.590	AVCA-OOL-02
	Fumed Oak, Oiled	1.750	AVCA-OFU-02

Weaved Seat, Solid Back

	Oak, White Oiled	1.590	AVCA-OWO-01
	Oak, Oiled	1.590	AVCA-OOL-01
	Fumed Oak, Oiled	1.750	AVCA-OFU-01

Notes:

- The COM option for seat adds 200 Euro plus material to the net price.
- Approved EN 16139 for extreme use.
- Felt gliders.
- Fumed colors will vary across the chair as the wood content of tanin will vary.
Read more under material information.

Dimensions

Height	820 mm
Width	550 mm
Seat Height	460 mm
Seat Depth	450 mm
Arm Height	653 mm
Box	630 x 590 x 900 mm
Weight	7,5 kg

Arv Lounge Chair
David Thulstrup

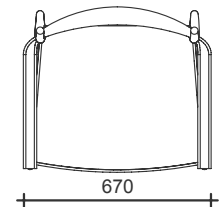
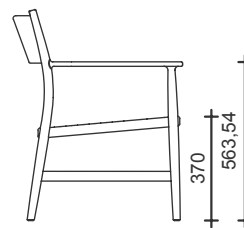
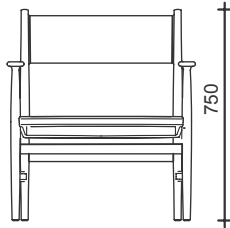

Weaved Seat, Weaved Back

EURO ex. VAT

#Reference

	Oak, White Oiled	3.140	AVCL-OWO-02
	Oak, Oiled	3.140	AVCL-OOL-02
	Fumed Oak, Oiled	3.370	AVCL-OFU-02

Notes:



- Approved for hotel / restaurant (EN 15372: 2016, Test level 2 General)
- Felt gliders.
- Fumed colors will vary accross the chair as the wood content of tanin will vary.
Read more under material information.

Dimensions

Height	750 mm
Width	670 mm
Seat Depth	650 mm
Seat Height	370 mm
Box	740 x 720 x 800 mm
Weight	15 kg



	EURO ex. VAT	#Reference
Arv Dining Chair Cushion	170	AVCC
Arv Lounge Chair Cushion	280	AVCC-LO

	Upholstery	# Reference
	Spectrum, Brandy Leather - 30155	66
	Spectrum, Cinnamon Leather - 30146	65

Notes:

- The COM option for seat adds 200 Euro plus material to the net price.





Arkade Chair

by Nanna Ditzel

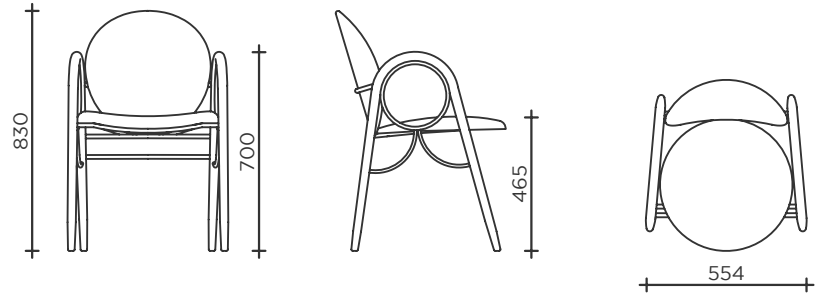





Arkade Dining Chair
Nanna Ditzel



	EURO ex. VAT	#Reference
 Oak, White Oiled	1.890	ARCA-OWO
 Oak, Oiled	1.890	ARCA-OOL
 Fumed Oak, Oiled	2.010	ARCA-OFU

Metal Frame Powder Coating	# Reference
 Black	BO
 Brass	BR
 Chrome	CH

Dimensions	
Height	830 mm
Width	554 mm
Seat Height	465 mm
Seat Depth	595 mm
Armrest Height	700 mm
Box	630 x 590 x 900 mm
Weight	10 kg

Upholstery	# Reference
 Spectrum, Oyster Leather - 30157	62
 Spectrum, Almond Leather - 30150	63
 Spectrum, Brandy Leather - 30155	66
 Spectrum, Cinnamon Leather - 30146	65
 Savanne, Black Leather - 30314	61
 Moss, Cream Fabric - 0019	33

Notes:

- The COM option starts from 270 Euro plus material to the net price.
- Felt gliders.
Read more under material information.





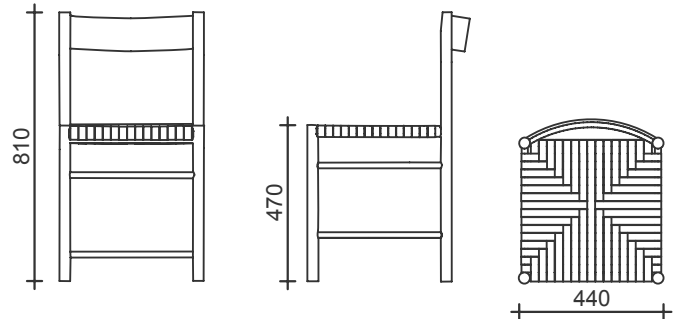

F Chair

by Rasmus B. Fex

F Dining Chair
Rasmus B. Fex



	EURO ex. VAT	#Reference
 Oak, Oiled, Black Webbing Seat	640	FCCX-OOL-11
 Fumed Oak, Oiled, Natural Linen, Webbing Seat	700	FCCX-OFU-04
 Ash, Black Lacquer / Out of collection in June 2025	700	FCCX-ABA-11
 Ash, Green Lacquer / Out of collection in June 2025	700	FCCX-AGR-12
 Ash, Red Lacquer / Out of collection in June 2025	700	FCCX-ARE-13

Notes:





- Approved for hotel / restaurant (EN 15372: 2016, Test level 2 General)
- Felt gliders.

Dimensions

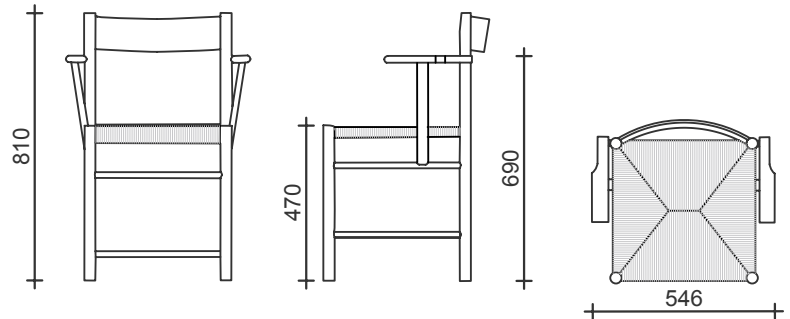
Height	810 mm
Width	440 mm
Seat Height	470 mm
Seat Width	440 mm
Box	500 x 500 x 830 mm
Weight	5 kg

F Dining Chair with Armrest
Rasmus B. Fex



	EURO ex. VAT	#Reference
 Oak, Oiled, Black Webbing Seat	820	FCCA-OOL-11
 Fumed Oak, Oiled, Natural Linen, Webbing Seat	880	FCCA-OFU-04
 Ash, Black Lacquer / Out of collection in June 2025	880	FCCA-ABA-11
 Ash, Green Lacquer / Out of collection in June 2025	880	FCCA-AGR-12
 Ash, Red Lacquer / Out of collection in June 2025	880	FCCA-ARE-13

Notes:

- Approved for hotel / restaurant (EN 15372: 2016, Test level 2 General)
- Felt gliders.





Dimensions

Height	810 mm
Width	545 mm
Seat Height	45m mm
Seat Width	470 mm
Arm Height	690 mm
Box	530 x 590 x 840 mm
Weight	5,5 kg

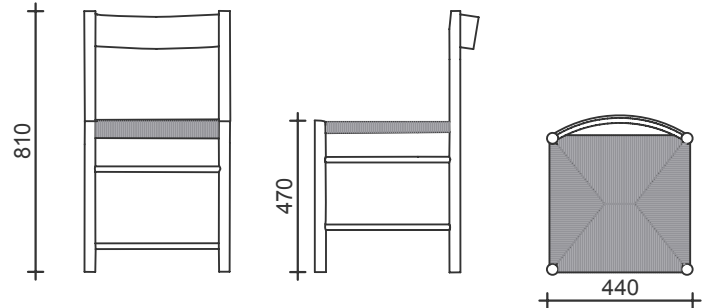
F Dining Chair with Paper Cord

Rasmus B. Fex



Paper Cord	EURO ex. VAT	#Reference
 Oak, Oiled	880	FCCX-OOL-01
 Fumed Oak, Oiled	940	FCCX-OFU-01
 Ash, Black Lacquer / Out of collection in June 2025	940	FCCX-ABA-01
 Ash, Green Lacquer / Out of collection in June 2025	940	FCCX-AGR-01
 Ash, Red Lacquer / Out of collection in June 2025	940	FCCX-ARE-01

Notes:

- Approved for hotel / restaurant use:
EN 1022:2005, EN 16139:2013
- Felt gliders.
- Seat in paper cord.
The weaving is a traditional Danish triangle shape used for generations. Since cords need to overlap it is not possible to make four triangles that meet exactly in the middle - they will always overlap. Also, the four lines going from the edge of the seat to the center will never be 100 pct. straight. This is a handmade product and part of the character of the chair.





Dimensions

Height	810 mm
Width	440 mm
Seat Height	470 mm
Seat Width	440 mm
Box	500 x 500 x 830 mm
Weight	5 kg

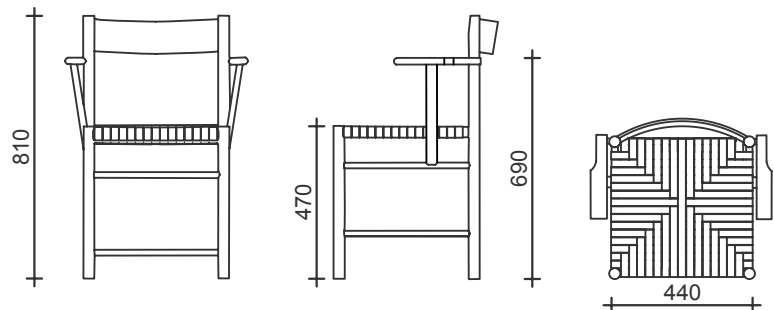
F Dining Chair with Armrest and Paper Cord

Rasmus B. Fex



	Paper Cord	EURO ex. VAT	#Reference
	Oak, Oiled	1.060	FCCA-OOL-01
	Fumed Oak, Oiled	1.120	FCCA-OFU-01
	Ash, Black Lacquer / Out of collection in June 2025	1.120	FCCA-ABA-01
	Ash, Green Lacquer / Out of collection in June 2025	1.120	FCCA-AGR-01
	Ash, Red Lacquer / Out of collection in June 2025	1.120	FCCA-ARE-01

Notes:

- Approved for hotel / restaurant use:
EN 1022:2005, EN 16139:2013
- Felt gliders.
- Seat in paper cord.
The weaving is a traditional Danish triangle shape used for generations. Since cords need to overlap it is not possible to make four triangles that meet exactly in the middle - they will always overlap. Also, the four lines going from the edge of the seat to the center will never be 100 pct. straight. This is a handmade product and part of the character of the chair.

Dimensions

Height	810 mm
Width	545 mm
Seat Height	45 mm
Seat Width	470 mm
Arm Height	690 mm
Box	530 x 590 x 840 mm
Weight	5,5 kg







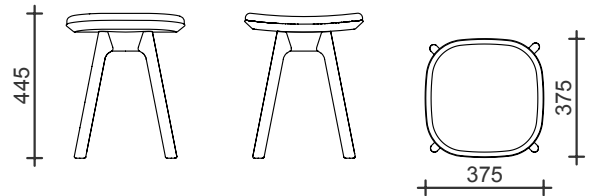

Pauline Bar Stool

by OEO Studio

Pauline Bar Stool 45 cm
OEO Studio



	EURO ex. VAT	#Reference
 Oak, Oiled	720	PA45-OOL
 Fumed Oak, Oiled	810	PA45-OFU

	Upholstery	# Reference
	Hallingdal, Grey Fabric - 0113	35
	Moss, Cream Fabric - 0019	33
	Spectrum, Oyster Leather - 30157	62
	Spectrum, Almond Leather - 30150	63
	Spectrum, Brandy Leather - 30155	66
	Spectrum, Cinnamon Leather - 30146	65
	Savanne, Black Leather - 30314	61

Dimensions	
Height	445 mm
Seat Width	375 mm
Seat Depth	375 mm
Box	420 x 420 x 500 mm
Weight	5 kg





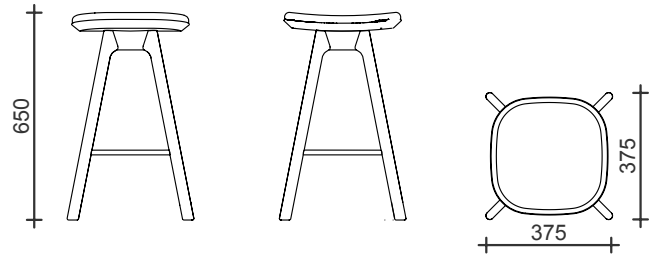

Notes:

- The COM option for seat adds 135 Euro plus material to the net price.
- Felt gliders.
- Approved for hotel / restaurant use: EN 1022:2005, EN 16139:2013.

Pauline Bar Stool 65 cm
OEO Studio



	EURO ex. VAT	#Reference
 Oak, Oiled	1.020	PA65-OOL
 Fumed Oak, Oiled	1.110	PA65-OFU

	Upholstery	# Reference
	Hallingdal, Grey Fabric - 0113	35
	Moss, Cream Fabric - 0019	33
	Spectrum, Oyster Leather - 30157	62
	Spectrum, Almond Leather - 30150	63
	Spectrum, Brandy Leather - 30155	66
	Spectrum, Cinnamon Leather - 30146	65
	Savanne, Black Leather - 30314	61

Dimensions	
Height	650 mm
Seat Width	375 mm
Seat Depth	375 mm
Box	420 x 420 x 700 mm.
Weight	6 kg





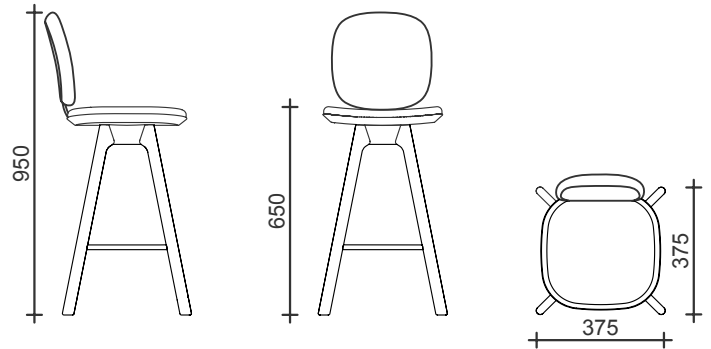

Notes:

- The COM option for seat adds 135 Euro plus material to the net price.
- Felt gliders.
- Approved for hotel / restaurant use: EN 1022:2005, EN 16139:2013.

Pauline Comfort Bar Stool 65 cm
OEO Studio



	EURO ex. VAT	#Reference
 Oak, Oiled	1.390	PA66-OOL
 Fumed Oak, Oiled	1.480	PA66-OFU

Upholstery	# Reference
 Hallingdal, Grey Fabric - 0113	35
 Moss, Cream Fabric - 0019	33
 Spectrum, Oyster Leather - 30157	62
 Spectrum, Almond Leather - 30150	63
 Spectrum, Brandy Leather - 30155	66
 Spectrum, Cinnamon Leather - 30146	65
 Savanne, Black Leather - 30314	61

Dimensions	
Height	950 mm
Seat Height	650 mm
Seat Width	375 mm
Seat Depth	375 mm
Box	490 x 490 x 1000 mm.
Weight	8 kg







Notes:

- The COM option for seat and back adds 200 Euro plus material to the net price.
- Felt gliders.
- Approved for hotel / restaurant use: EN 1022:2005, EN 16139:2013.

Pauline Bar Stool 65 cm with metal legs
OEO Studio



	EURO ex. VAT	#Reference
 Oak, Oiled	800	PA65-OOL-BM
 Fumed Oak, Oiled	890	PA65-OFU-BM

	Upholstery	# Reference
	Hallingdal, Grey Fabric - 0113	35
	Moss, Cream Fabric - 0019	33
	Spectrum, Oyster Leather - 30157	62
	Spectrum, Almond Leather - 30150	63
	Spectrum, Brandy Leather - 30155	66
	Spectrum, Cinnamon Leather - 30146	65
	Savanne, Black Leather - 30314	61

Dimensions	
Height	650 mm
Seat Width	375 mm
Seat Depth	375 mm
Box	420 x 420 x 700 mm.
Weight	5 kg





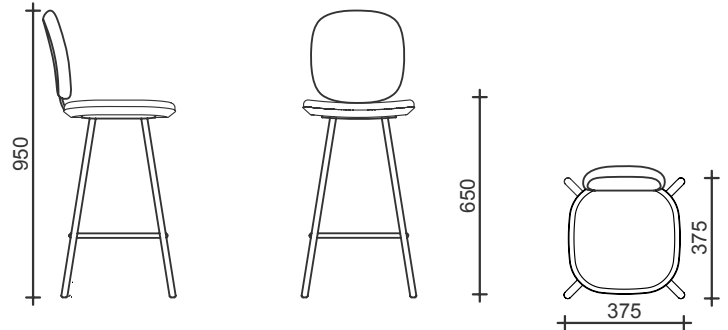

Notes:

- The COM option for seat adds 135 Euro plus material to the net price.
- Felt gliders.
- Approved for hotel / restaurant use: EN 1022:2005, EN 16139:2013.
- Powder coated, matt, steel legs and footrest.

Pauline Comfort Bar Stool 65 cm with metal legs
OEO Studio



	EURO ex. VAT	#Reference
 Oak, Oiled	1.160	PA66-OOL-BM
 Fumed Oak, Oiled	1.250	PA66-OFU-BM

Upholstery	# Reference
 Hallingdal, Grey Fabric - 0113	35
 Moss, Cream Fabric - 0019	33
 Spectrum, Oyster Leather - 30157	62
 Spectrum, Almond Leather - 30150	63
 Spectrum, Brandy Leather - 30155	66
 Spectrum, Cinnamon Leather - 30146	65
 Savanne, Black Leather - 30314	61

Dimensions	
Height	950 mm
Seat Height	650 mm
Seat Width	375 mm
Seat Depth	375 mm
Box	490 x 490 x 1000 mm.
Weight	8 kg

Notes:

- The COM option for seat adds 135 Euro plus material to the net price.
- Felt gliders.
- Approved for hotel / restaurant use: EN 1022:2005, EN 16139:2013.
- Powder coated, matt, steel legs and footrest.

Pauline Bar Stool 65 cm with wooden seat
 OEO Studio



		EURO ex. VAT	#Reference
	Oak, Oiled	800	PA65-OOL-BM-05
	Fumed Oak, Oiled	890	PA65-OFU-BM-05

Note:

- Approved for hotel / restaurant use:
EN 1022:2005, EN 16139:2013.
- Plastic glider.
- Steel legs and footrest, powder coated matt black.
- Seat in solid oak.





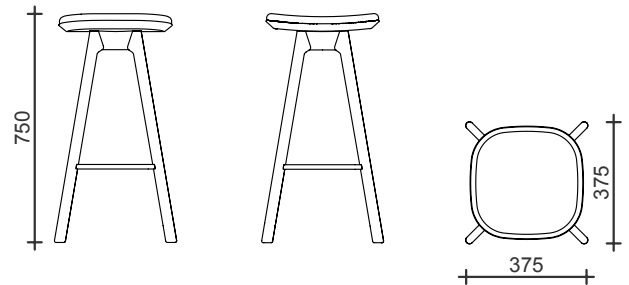

Dimensions

Height	650 mm
Seat Width	375 mm
Seat Depth	375 mm
Box	420 x 420 x 700 mm
Weight	8 kg

Pauline Bar Stool 75 cm
OEO Studio



	EURO ex. VAT	#Reference
 Oak, Oiled	1.020	PA75-OOL
 Fumed Oak, Oiled	1.110	PA75-OFU

	Upholstery	# Reference
 Hallingdal, Grey Fabric - 0113		35
 Moss, Cream Fabric - 0019		33
 Spectrum, Oyster Leather - 30157		62
 Spectrum, Almond Leather - 30150		63
 Spectrum, Brandy Leather - 30155		66
 Spectrum, Cinnamon Leather - 30146		65
 Savanne, Black Leather - 30314		61

Dimensions	
Height	750 mm
Seat Width	375 mm
Seat Depth	375 mm
Box	490 x 490 x 800 mm
Weight	6,5 kg





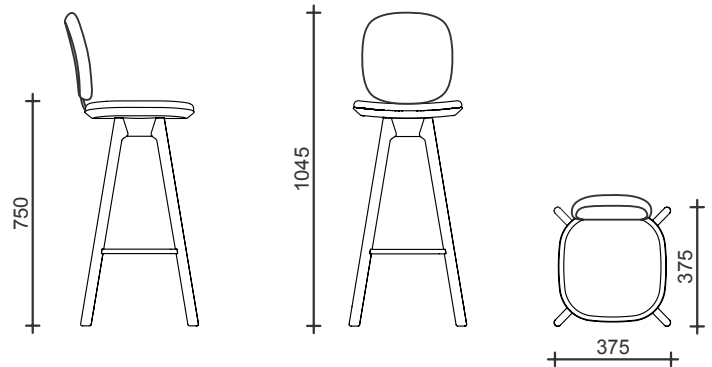

Notes:

- The COM option for seat adds 135 Euro plus material to the net price.
- Felt gliders.
- Approved for hotel / restaurant use: EN 1022:2005, EN 16139:2013.

Pauline Comfort Bar Stool 75 cm
OEO Studio



	EURO ex. VAT	#Reference
 Oak, Oiled	1.390	PA76-OOL
 Fumed Oak, Oiled	1.480	PA76-OFU

Upholstery	# Reference
 Hallingdal, Grey Fabric - 0113	35
 Moss, Cream Fabric - 0019	33
 Spectrum, Oyster Leather - 30157	62
 Spectrum, Almond Leather - 30150	63
 Spectrum, Brandy Leather - 30155	66
 Spectrum, Cinnamon Leather - 30146	65
 Savanne, Black Leather - 30314	61

Dimensions	
Height	1045 mm
Seat Height	750 mm
Seat Width	375 mm
Seat Depth	375 mm
Box	490 x 490 x 1100 mm.
Weight	8,5 kg





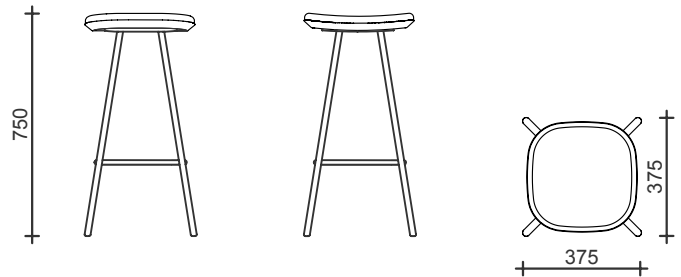

Notes:

- The COM option for seat and back adds 200 Euro plus material to the net price.
- Felt gliders.
- Approved for hotel / restaurant use: EN 1022:2005, EN 16139:2013.

Pauline Bar Stool 75 cm metal legs
OEO Studio



		EURO ex. VAT	#Reference
	Oak, Oiled	800	PA75-OOL-BM
	Fumed Oak, Oiled	890	PA75-OFU-BM

	Upholstery	# Reference
	Hallingdal, Grey Fabric - 0113	35
	Moss, Cream Fabric - 0019	33
	Spectrum, Oyster Leather - 30157	62
	Spectrum, Almond Leather - 30150	63
	Spectrum, Brandy Leather - 30155	66
	Spectrum, Cinnamon Leather - 30146	65
	Savanne, Black Leather - 30314	61

Dimensions	
Height	750 mm
Seat Width	375 mm
Seat Depth	375 mm
Box	490 x 490 x 800 cm
Weight	8 kg





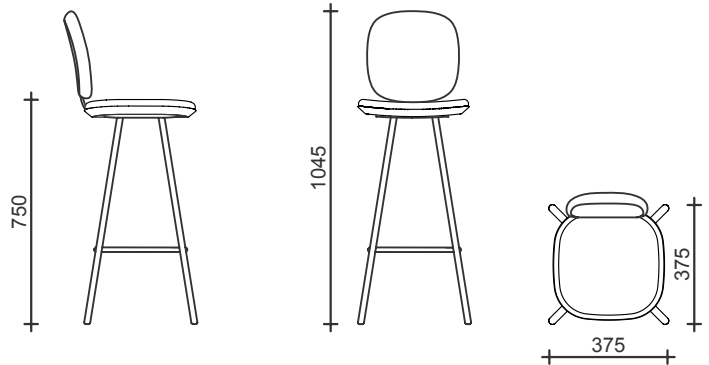

Notes:

- The COM option for seat adds 135 Euro plus material to the net price.
- Felt gliders.
- Approved for hotel / restaurant use: EN 1022:2005, EN 16139:2013.
- Powder coated, matt, steel legs and footrest.

Pauline Comfort Bar Stool 75 cm metal legs
OEO Studio



	EURO ex. VAT	#Reference
 Oak, Oiled	1.160	PA76-OOL-BM
 Fumed Oak, Oiled	1.250	PA76-OFU-BM

Upholstery	# Reference
 Hallingdal, Grey Fabric - 0113	35
 Moss, Cream Fabric - 0019	33
 Spectrum, Oyster Leather - 30157	62
 Spectrum, Almond Leather - 30150	63
 Spectrum, Brandy Leather - 30155	66
 Spectrum, Cinnamon Leather - 30146	65
 Savanne, Black Leather - 30314	61

Dimensions	
Height	1045 mm
Seat Height	750 mm
Seat Width	375 mm
Seat Depth	375 mm
Box	490 x 490 x 1100 mm
Weight	9,5 kg

Notes:

- The COM option for seat adds 200 Euro plus material to the net price.
- Felt gliders.
- Approved for hotel / restaurant use: EN 1022:2005, EN 16139:2013.
- Powder coated, matt, steel legs and footrest.

Pauline Barstol 75 cm with wooden seat
 OEO Studio



		EURO ex. VAT	#Reference
	Oak, Oiled	800	PA75-OOL-BM-05
	Fumed Oak, Oiled	890	PA75-OFU-BM-05

Note:

- Approved for hotel / restaurant use:
 EN 1022:2005, EN 16139:2013.
- Plastic glider.
- Steel legs and footrest, powder coated matt black.
- Seat in solid oak.

Dimensions

Height	750 mm
Seat Width	375 mm
Seat Depth	375 mm
Box	490 x 490 x 800 mm
Weight	8,5 kg







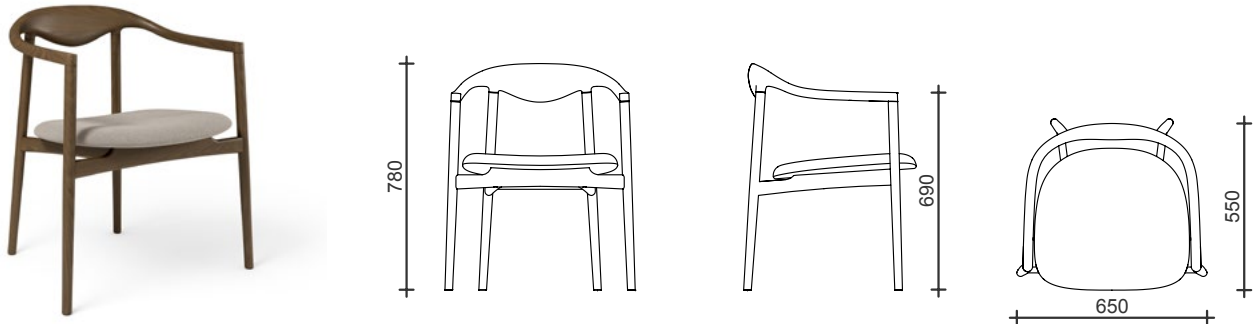

Jari Chair

by OEO Studio



	EURO ex. VAT	#Reference
 Oak, Oiled	2.480	JACA-OOL
 Fumed Oak, Oiled	2.600	JACA-OFU

	Upholstery	# Reference
	Spectrum, Oyster Leather - 30157	62
	Spectrum, Almond Leather - 30150	63
	Spectrum, Brandy Leather - 30155	66
	Spectrum, Cinnamon Leather - 30146	65
	Savanne, Black Leather - 30314	61
	Moss, Cream Fabric - 0019	33

Dimensions	
Height	780 mm
Width	650 mm
Seat Height	460 mm
Seat Depth	550 mm
Armrest Height	690 mm
Box	670 x 630 x 800 mm
Weight	10 kg

Notes:

- The COM seat option adds 270 Euro plus material to the net price.
- Felt gliders.
Read more under material information.







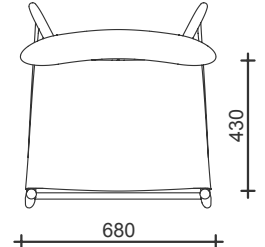
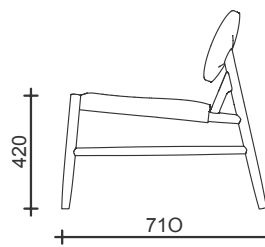
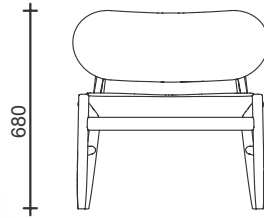

Ferdinand Lounge Chair

by OEO Studio

Ferdinand Lounge Chair
OEO Studio



	EURO ex. VAT	#Reference
 Oak, Oiled	3.830	FECX-OOL
 Fumed Oak, Oiled	4.100	FECX-OFU

	Upholstery	# Reference
	Spectrum, Oyster Leather - 30157	62
	Spectrum, Almond Leather - 30150	63
	Spectrum, Brandy Leather - 30155	66
	Spectrum, Cinnamon Leather - 30146	65
	Savanne, Black Leather - 30314	61
	Moss, Cream Fabric - 0019	33

Dimensions	
Height	680 mm
Width	680 mm
Seat Depth	430 mm
Seat Height	420 mm
Box	740 x 720 x 800 mm
Weight	15 kg

Notes:

- The COM seat option adds 270 Euro plus material to the net price.
- Felt gliders.
Read more under material information.



Karm Sofa

by David Thulstrup

Karm Lounge Chair
David Thulstrup

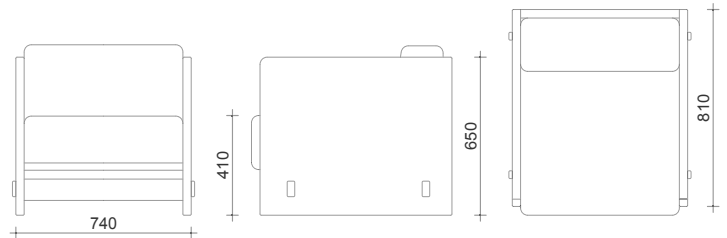

	EURO ex. VAT	#Reference
 Oak, Oiled	6.250	KA1S-OOL
 Fumed Oak, Oiled	6.620	KA1S-OFU

Upholstery	# Reference
 Moss, Cream Fabric - 0019	33

Dimensions	
Length	740 mm
Height	650 mm
Width	810 mm
Seat Depth	570 mm
Seat Height	420 mm

Notes:

- The very core of the KARM sofa's design comes from the strong variation in the wood that makes every piece unique. Some sofas have small or large knots and some will have a strong grain texture while others will have less.

Karm Sofa 2 Seaters
David Thulstrup

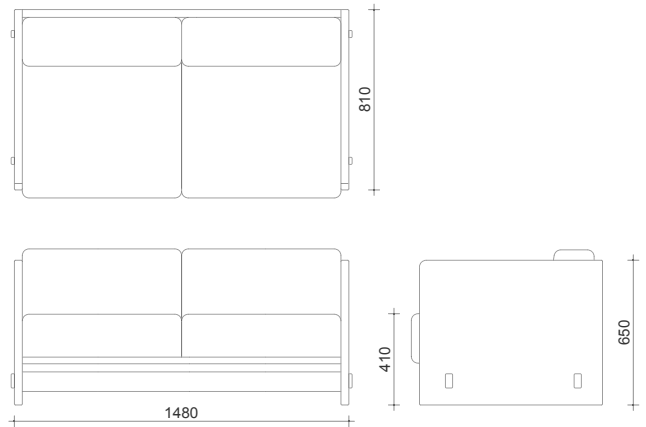

	EURO ex. VAT	#Reference
 Oak, Oiled	8.980	KA2S-OOL
 Fumed Oak, Oiled	9.720	KA2S-OFU

Upholstery	# Reference
 Moss, Cream Fabric - 0019	33

Dimensions	
Length	1480 mm
Height	650 mm
Width	810 mm
Seat Depth	570 mm
Seat Height	420 mm

Notes:

- The very core of the KARM sofa's design comes from the strong variation in the wood that makes every piece unique. Some sofas have small or large knots and some will have a strong grain texture while others will have less.

Karm Sofa 3 Seaters
David Thulstrup

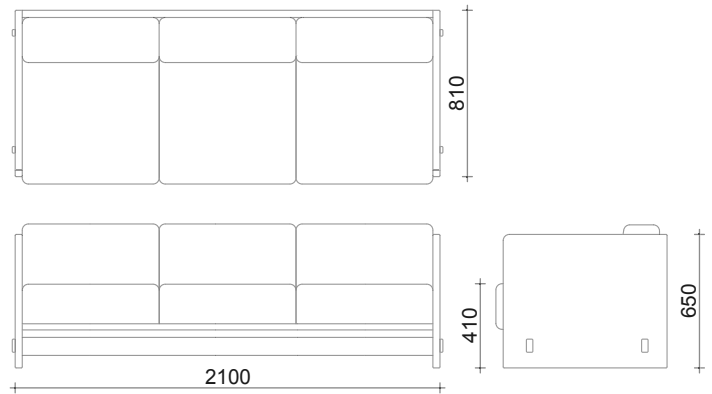

	EURO ex. VAT	#Reference
 Oak, Oiled	11.460	KA3S-OOL
 Fumed Oak, Oiled	12.340	KA3S-OFU

Upholstery	# Reference
 Moss, Cream Fabric - 0019	33

Dimensions	
Length	2100 mm
Height	720 mm
Width	810 mm
Seat Depth	570 mm
Seat Height	420 mm

Notes:

- The very core of the KARM sofa's design comes from the strong variation in the wood that makes every piece unique. Some sofas have small or large knots and some will have a strong grain texture while others will have less.

Lighting





Lune Lamp

by Sverre Uhnger

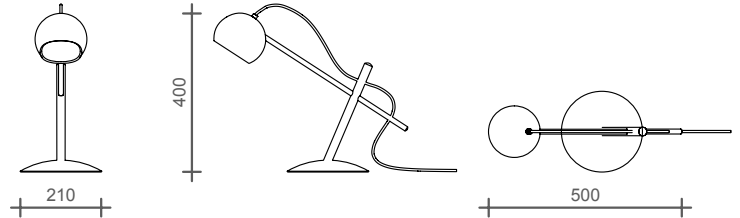
Lune Table Lamp
Sverre Uhnger



	EURO ex. VAT	#Reference
 Oak, White Oiled, White Electric Cord	710	LUTL-OWO
 Oak, Oiled, Black Electric Cord	710	LUTL-OOL
 Fumed Oak, Oiled, Black Electric Cord	830	LUTL-OFU

Notes:



- Bulb is not included.
- * LED bulb GU 10, max 6 watt.
- * Only approved for EU area.

Dimensions

Length	500 mm
Height	400 mm
Shade	Ø 140 mm
Base	210 mm
Box	590 x 390 x 240 mm
Weight	4 kg

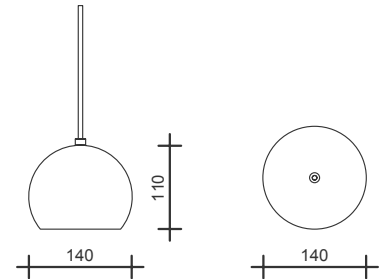
Lune Pendant Lamp
Sverre Uhnger



	EURO ex. VAT	#Reference
 Oak, White Oiled, White Electric Cord	410	LUPE-OWO
 Oak, Oiled, Black Electric Cord	410	LUPE-OOL
 Fumed Oak, Oiled, Black Electric Cord	480	LUPE-OFU

Notes:

- Bulb is not included.
- * LED bulb GU 10, max 6 watt.
- * Only approved for EU area.

Dimensions

Shade	Ø 140 mm
Wire	3 m
Box	200 x 200 x 260 mm
Weight	0,7 kg

Complements



	EURO ex. VAT	#Reference
Complete Sample Box	180	KCSB
Leather Sample Set	40	KCLES
Fabric Sample Set	20	KCTS
Wooden Sample (each piece)	10	KCWS
Compact Laminate Set	40	KCLAS
Metal Sample Set	40	KCMS
Webbing Sample Set	10	KCGS
Maintenance Kit	60	KCXX

General information



Employees

We employ a variety of people with different backgrounds, education, ethnicity, age and gender.



Education

We employ a large number of trainees and apprentices to support the industry's future.



Union

We follow the collective agreement for the largest trade union in Denmark (3F) to secure workers' rights in the production team.



Safety

Our health and safety regulation are audited on a regular basis by the Danish Working Authority.



Insurance

We offer extra health insurance for our employees and their families.



Wood

We only use certified wood - FSC © or PEFC ©.



Wind Power

Our factory buys electricity from suppliers, where the greatest possible electricity comes from Danish wind farms. This means that we only buy certified Co2 neutral electricity.



Heating

We use waste wood to generate heat - minimizing our carbon footprint.



Local

We prioritize local suppliers to minimize transport emissions.



Packaging

We only use recyclable cardboard and plastic in packaging.



Wood

Wood & Treatments

We use only certified wood from high quality suppliers. Our craftsmen choose carefully the wood for each piece of furniture. Selected wood sorts for each piece of furniture can be seen under product pages. Please note that all the models are not available in all species.



Natural Oak

North European Oak is mostly straight grained with a medium to coarse texture. It is widely used in Scandinavian furniture because of its strength.



Black Painted Oak

Paint with a semi matt finish. The grains of the oak is still visible. The top coat gives a hard protection and seals the wood.



Fumed Oak

We “home fume” every piece of furniture in our work shop. Every log has different reaction to the fuming so the color varies across each furniture.



Natural Beech

The grain of the natural beech is straight, with a fine to medium uniform texture. It is strong and durable with a good resistance to abrasion.



Oak White Oiled

Light pigments give the grains a brighter tint. It is water-repellent, dirt-resistant and durable.



Oiled Beech

Oil is developed from natural oils and waxes to provide the most durable protection. It brings out the warmth and depth of the wood.



Oiled Oak

Oil is developed from natural oils and waxes to provide the most durable protection. It brings out the warmth and depth of the wood.

Wood



Red Lacquered Ash

The colour and a polyurethane top coat is applied to give a semi matt finish. Lacquered ash is durable and resistant against water, moist and heat.

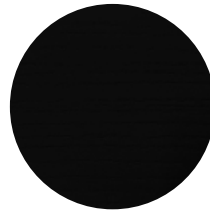

Black Lacquered Ash

The colour and a polyurethane top coat is applied to give a semi matt finish. Lacquered ash is durable and resistant against water, moist and heat.



Oiled Walnut

We use an American walnut because of its luxurious dark brown colour and its grain is revealed by a wax oil treatment.



Green Lacquered Ash

The colour and a polyurethane top coat is applied to give a semi matt finish. Lacquered ash is durable and resistant against water, moist and heat.



Oiled Cherry

American cherry is a supreme hardwood species from the U.S. hardwood forests and is unique to North America, with warm colour tones and superb finishing qualities.



White Oiled Maple

Growing naturally in the hardwood forests of North America, Maple is one of the most prolific and sustainable species with creamy to pale reddish brown and grained with a fine texture.

Compact Laminate

Compact laminate is made of special paper compressed into a firm tabletop in the process of high pressure and heat. We only use certified compact laminate of the highest quality, which our craftsmen carefully select for Bølling Tray Table. Each side of the compact laminate has a different colour. Each colour combination is selected to suit all the types of wood we use for Bølling Tray Table.



BASE

The classic model with Black and White trays has been discretely adjusted for softer contrast and a bit of warmth.

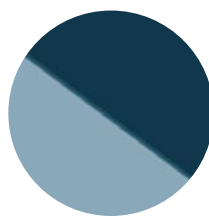

WATER

A deep marine Blue note that, like an anchor, brings calm and soothing tones to any context. On the reverse side of Water, is a brighter airy Blue, that uplifts with light contrast and tone-in-tone variation.

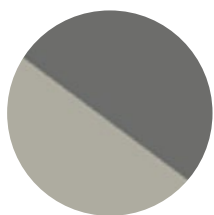

STONE

Two classic shades of slightly warm Grey, that will complement most settings. Each side of Stone has its own light and dark grey. In combination they bring subtle and soft contrasts.



SUNNY

The warm Ochre Yellow is a reminiscent of ancient pigment colours, yet with vibrant energy. On the other side of the reversible tray, Sunny has a light creamy tone, that adds contrast and variation.



EARTH

A light caramel Beige that perfectly matches the natural tones of the oakwood frame, and comes across as monochrome, warm and modern. On the other side of the reversible tray, Earth has a dark chocolate Brown.

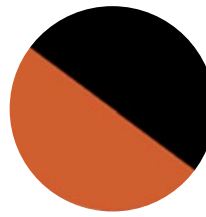

CLAY

This vibrant burnt Orange has classic notes of terracotta and cognac leather, both complementing and uplifting its interior context. On the other side of the tray, Clays has an off-Black.



LEAF

Two shades of green make up the Leaf colourway. On one side of the tray is a deep dark moss-like Green, and on the other; a lighter olive Green. In combination, the two greens complement each other with soft contrast.



RED

The warm red and black provide a classic contrast and variation that both complementing and uplifting its interior context.





Upholstery

Fabric

We create a simple selection of fabrics and leather from the world's best producers considering the quality, sustainability, ethics and safety of their products. All the leathers are chosen carefully from [Sørensen Leather](#) which are originated from European rawhide and fabric from [Kvadrat](#).



Moss by Sahco , 0019
[Kvadrat](#)

Sand
Designed by Vincent van Duysen and Anna Vilhelmine Ebbesen.
Produced in Belgium.
52% cotton 22% viscose 14% polyacrylic 6% linen 3% nylon 3% polyester (worsted), 5% nylon.
50.000 Martindale

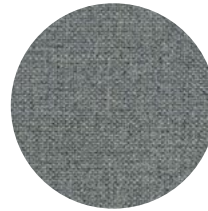

Hallingdal 65, 0113
[Kvadrat](#)

Grey
Designet by Nanna Ditzel
Produced in Norge.
70% wool, 30 % viscose.
100.000 Martindale



Leather

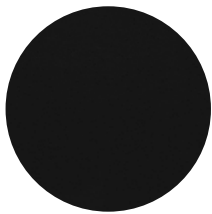

Savanne, 30314
[*Sørensen Leather*](#)

Black
Aniline Leather
Surface: Natural markings are part of the appeal
Finish Elegant matt with a soft, silky, velvety feel.

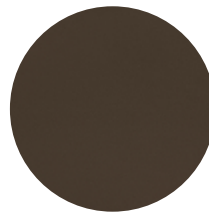

Spectrum, 30146
[*Sørensen Leather*](#)

Cinnamon
Aniline Leather
Surface: Natural markings are part of the appeal
Finish Elegant matt with a soft, silky, velvety feel.



Spectrum, 30155
[*Sørensen Leather*](#)

Brandy
Aniline Leather
Surface: Natural markings are part of the appeal
Finish Elegant matt with a soft, silky, velvety feel.

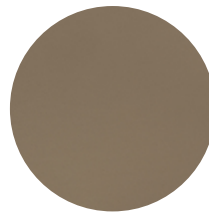

Spectrum, 30150
[*Sørensen Leather*](#)

Almond
Aniline Leather
Surface: Natural markings are part of the appeal
Finish Elegant matt with a soft, silky, velvety feel.



Spectrum, 30157
[*Sørensen Leather*](#)

Oyster
Aniline Leather
Surface: Natural markings are part of the appeal
Finish Elegant matt with a soft, silky, velvety feel.



Custom Upholstery Solutions

For COM and CU materials, an additional charge applies, which is detailed on each product's page in the price list. Please note that discounts do not apply to this additional charge. The customer would be responsible for supplying or paying for the fabric or leather. The measurements are based on following standards:
Fabric with 146 cm, width and 5m² leather skin.

Product	Fabric per piece	Leather per piece
JARI	75 cm	0,8 m ²
ARV	75 cm	0,8 m ²
ARKADE	110 cm	1,3 m ²
PAULINE	45 cm	0,2 m ²
PAULINE COMFORT	45 cm	0,7 m ²
FERDINAND	75 cm	0,8 m ²
KARM Lounge	2 m	X
KARM Sofa 2 seater	4 m	X
KARM Sofa 3 seater	6 m	X

General Terms & Conditions

How to order

Send an e-mail to info@brdr-kruger.dk

- Please write “order” in subject line
- Write amount
- Write Product number as mentioned in the price list
- Write Upholstery Reference as mentioned in the price list
– if applicable.

You will receive an order confirmation (OC) within a few days. Please read carefully.

Brdr. Krüger is “made to order” and only carries few products in stock. Delivery time may vary, the ETD will show on OC.

Once you receive the invoice, your order is either ready for pick up, or send by forwarder and you will receive a tracing link from the chosen forwarder.

Currency & Effective Date

This price list is valid from 01.01.2025 and cancels all prior price lists.

Reservation is made for any errors and omissions.

Furthermore, below general terms and conditions shall apply to all contracts under which Brdr. Krüger A/S (Brdr. Krüger) is the supplier/subsupplier.

Order Confirmation

Orders shall not be binding on Brdr. Krüger until the customer has received Brdr. Krüger's written order confirmation.

Order Cancellation

Orders can be canceled based on the following rules:

- Within 0-5 days after the order confirmation is sent: No fee.
- After 5 days from the order confirmation date: A fee of 15% of the net price (excluding VAT) applies.

Delivery

All orders are subject to a shipping surcharge. The confirmed OC will specify the Incoterms and shipment fee according to the agreement made.

Brdr. Krüger uses external freight forwarders, and transit times may vary depending on the destination country.

If Ex-Works terms are agreed upon, the customer is responsible for all pickup arrangements included all documentation. Pick up must be coordinated with Brdr. Krüger prior to collection. Brdr. Krüger reserves the right to withhold the release of orders if the forwarder cannot provide the necessary information: Brdr. Krüger's OC number or the customer's name.

If the goods need to be stored for a period longer than agreed, Brdr. Krüger reserves the right to charge storage fee.

Complaints

The physical product must be inspected upon delivery. Damage incurred in transit as well as any defects and deficiencies on the product incurred as a result of transportation must be recorded on the freight bill upon delivery. Brdr. Krüger must be notified in writing of any complaints about product defects and deficiencies within

24 hours of delivery. If the complaint is made in due time and with the acceptance of Brdr. Krüger, the customer is entitled to demand a replacement delivery or to have the defect remedied. The customer cannot demand a reduction or a compensation. Complaints/replacements can only be made to the customer's address, unless delivery has been made directly to the end consumer.

Terms Of Payment

Unless otherwise agreed, payment must be made before the item is shipped. New customers always pay 14 days before the item is shipped. Customer orders must always be paid upon receipt of OC Brdr. Krüger may decide that the customer must pay in advance if the customer's balance is due, has previously been due or if the order amount exceeds Brdr. Krüger approved credit limit. In the event of non-payment after the deadline, a fee of DKK 150 excluding VAT will be added for the 1st and 2nd reminders. Then interest is calculated at 1.5% per—month from the due date. If there is no payment after the 3rd reminder, the case is transferred to debt collection.

Observation Of Title

Title to the goods shall not pass to the customer until Brdr. Krüger (or any third party to whom Brdr. Krüger has assigned its rights to the purchase price) has received the full purchase price and been reimbursed any expenses incurred.

Limitation Of Liability

Brdr. Krüger will assume no liability for any loss as a result of delays, defects or any other breach of contract, unless such loss was caused by gross negligence on the part of Brdr. Krüger. Brdr. Krüger will assume no liability for any indirect loss, including loss of profits, operating loss, goodwill, loss of customers, running costs or any other consequential economic loss.

Choice Of Law And Jurisdiction

Disputes between Brdr. Krüger and its customers shall be subject to Danish law, except for the international civil law rules of Danish law, and shall be settled by Brdr. Krüger's home court.

Measurements

The stated measurements in this document act only as a

The commercial warranty applicable to Brdr. Krüger products covers material and manufacturing process defects.

Products are under warranty for a period of 2 years as of the date of invoice sent to the original purchaser. The warranty is granted solely to the original purchaser of the product and is not transferable, either directly or indirectly, to any third party.

In accordance with this warranty, Brdr. Krüger undertakes to repair or replace with a similar product, according to its own criteria and free of charge, any product with any of the defects indicated above, provided that these arise under normal conditions of use.

These conditions are described in our "Care and maintenance" manual.

Exceptions To The Warranty

Upholsteries: Brdr. Krüger products include a variety of collections of upholsteries. Each of them is intended for a specific use and subject to the conditions of guarantee given by the manufacturer of them.

Exclusions To The Warranty

- Natural wear or wear caused by: unsuitable use, excessive scratching/scraping, sliding of objects on the surface, use of abrasive products, placing extremely hot or cold objects on the surface and use for which the product is not intended, on any surface finish and particularly when lacquered, varnished or melamine products are involved.
- Damage caused by mishandling of the products, produced directly or indirectly, as a result of the acts or omission of the Customer/Distributor, be it through fault or neglect. Amongst other things, blows, accidents, inexpert product assembly and installation, dragging products which do not incorporate rolling elements, sitting on tables, etc.
- Leaving the products at unsuitable locations exposed to extreme changes of temperature and/or humidity: in the vicinity of points at which heat or cold are generated, near humidifiers, etc.; and at locations exposed to the open air.
- Defects caused by unsuitable cleaning of the products (wrong methods or products, use of abrasive products), in violation of Brdr. Krüger's recommended guidelines.
- Defects caused by not cleaning or protecting (wood, lacquer, etc.) the products, not removing material or liquids which may immediately damage the surface, etc.
- Damage caused by unsuitable modifications to or operations on the products, or repair work performed by the Customer itself or a third party assigned by it.
- Concerning special orders, products manufactured

according to the Customer's specifications and materials provided by the customer for inclusion in the product-manufacturing process, including fabric and upholstery supplied by the Customer are not covered by the warranty.

- Changes in colour, grain and texture due to: the passing of time, exposure to natural light, different batches and/or the natural origin of certain materials, such as wood, leather or natural bres, or, in the event, the artisan origin of certain parts involved in the production process.
- Colour differences of less than Delta-E 1 (in the case of plain colours) compared to the colour chart between different batches in a single delivery.
- Slight variations in the physical appearance of the order compared with the visual representations or descriptions provided by catalogues, samples and display parts, particularly variations in the colour, texture and grain of wood, and in fabrics.
- Typical variations in leather, such as cracks, insect bites or creasing, and variations in the colour or formation of creases due to the elasticity of the leather.
- Marks (from fingers), dirt and shine on dark and/or matt finishes.
- Marks or darker areas caused by failure to suitably protect the contact surface.

Warranty Conditions

It is the Customer's responsibility to check the received product before and during unloading, and to:

- Note any incident on the delivery note: suspicion of faulty packaging and/or product, wrong number of packages, and in this event:
- Take photographs of the load/packaging/product and make a complaint urgently, providing all relevant information, by email to the email address on the order confirmation request sent to the Customer.

If the Customer detects a non-conformity, then it must proceed to report the fact by email to info@brdr-kruger.dk, including/ attaching:

1. Description of the defect.
2. Photos of the defect, in general and in detail.
3. Clear identification of the product (order number): legible photo of the label, copy of the delivery note, copy of the invoice.

Any claim made which fails to provide the information described will not be accepted by Brdr. Krüger.

In the event of incidents detected during assembly, the Customer must proceed to report the fact, as indicated, within a maximum period of 72 hours. Any claim made after this period will not be accepted by Brdr. Krüger.

The subsequent care instructions are recommendations only. For general surfaces, we recommend using a damp cloth and we recommend that you always use environmentally friendly cleaning products and care for your furniture regularly and frequently. Before using any cleaning product, you should test it on an inconspicuous spot. Please follow the cleaning product manufacturer's instructions.

Fabrics:

To care for fabrics, simply Hoover dust and lint regularly. Stain removal: Fresh stains can usually be removed quickly by wiping immediately with an absorbent, lint-free sponge or cloth. Start from the outer edge of the stain and work towards the centre to avoid creating a halo effect. We recommend using normal household distilled water to prevent limescale residue from building up on dark fabrics after drying. Treatment of persevering stains: Brush dry stains lightly with a soft brush (such as a clothes brush). Depending on the type of stain, the use of solvents may be necessary. In such cases, it is essential to consult a professional. Under no circumstances should fabric surfaces be rubbed vigorously. Please be sure to consult a specialist before using any solvent-based cleaning product.

Leather:

Leather furniture should not be exposed to direct sunlight and should be kept some distance away from sources of heat; otherwise, the leather can dry out and become rigid. To ensure that leather remains soft and supple and that its natural protective film against water and grease remains intact, we recommend that you treat your furniture once a year with a mild cleaner. Stain removal: Superficial dirt can be removed with a damp cloth as long as care is taken not to wet the leather and not to apply direct pressure. You should also avoid rubbing too hard. For cleaning, we recommend using a special leather cleaner in foam or liquid form. Small dirt stains or pen stains are best removed with a colourless pencil eraser. To prevent the leather from drying out, you should subsequently always apply a designated care product from a specialist retailer. Liquids should be dabbed away immediately with a cloth and, if necessary, wiped off with a little water. Please do not use any aggressive agents such as stain removers, turpentine, shoe polish, etc.

Metal:

Stain removal: For quick removal of contaminants on polished high-shine, matte chrome and aluminium surfaces, apply a glass cleaner with a clean, soft cloth and subsequently wipe the surface dry with a soft cloth. For stainless steel, we recommend using a special stainless

steel care spray, steel cleaner or detergent. Powder-coated surfaces should be cleaned with aqueous solutions made from pH-neutral (pH 5-8) detergents or cleaning products and soft, non-abrasive cloths, rags or industrial cotton batting. Always clean metal surfaces gently and without scrubbing so that the surface is not scratched. Never use cleaners containing granular substances, acetic acid or citric acid.

Wood:

Wood is long-lasting, especially when its qualities are properly exploited. Furniture made of wood reacts to its environment; exposure to light, for example, alters its colour. And it is able to adapt its own moisture content levels to that of its environment. In the case of excessive fluctuations in temperature and humidity, however, it reacts by cracking and warping. Brdr. Krüger treats its solid wood tabletops with oil and other treatments to highlight and protect the properties of the natural material. To avoid stains and other damage, liquids should be wiped away immediately. Brdr. Krüger seals its veneers with a high-quality finish. Because of this, a soft, slightly damp cloth – with a mild detergent in the case of stubborn dirt – is sufficient for cleaning solid wood and veneer surfaces. Wet surfaces should be dried immediately with a cloth.

Do not use any harsh cleaning agents or care products containing silicone or abrasives. If possible, avoid rubbing the surface while cleaning it, as this will make matte finishes shiny and charge the varnish with static electricity which will attract more dust. We do not recommend using furniture polish or wax, as they contain unsuitable solvents and/or colour additives and leave a coating that is very difficult to remove.

Laminate And Glass Table Tops:

Clean with a soft cloth tightly wrung out in clean water. For dirty surfaces, use a mild soap flake solution or a mild universal cleaning agent. Then polish with a soft, dry cloth.

<https://www.brdr-kruger.com/maintenance>

Check the goods when you receive it.

Our shipments are sometimes damaged during transport, even though we pack carefully. It is not always possible to check on the packaging whether the product is damaged in shipping.

To cover the transport damage, do the following:

1. While the driver is present: Unpack the items from the packaging and check them for damage before signing the shipment note.

If all goods are damaged, refuse receipt. If only some items are damaged or are slightly damaged, please write on the shipping note that the items are received subject to shipping damage.

2. The driver does not have time to wait: Please note on the consignment note that the goods are received subject to transport damage. Then check the goods and notify us immediately if the shipment is damaged.

It is very important that you immediately check the shipment for damage. You risk losing the right to cover the carrier's damages if not stated on the shipping note.

Brdr. Krüger is not responsible for damages caused during transport. On the other hand, we may hold the carrier responsible if you comply with your obligation to investigate the shipment upon receipt and respond promptly in the event that the shipment is damaged.

It is a good idea to take photos of the damage and of the consignment note, or to have documentation.

Contact Brdr. Krüger at info@brdr-kruger.dk or
Tel: +45 39 56 15 55

Contact Information



CUSTOMER SERVICE & SALES

Info@brdr-kruger.dk
T: +45 39 56 15 55
M: +45 20 93 09 59

PRESS

JONAS KRÜGER
Jonas@brdr-kruger.dk
T: +45 39 56 15 55
M: +45 30 25 61 31

PRODUCTION HQ

BRDR. KRÜGER
Walgerholm 20
DK-3500

SHOWROOM

Bredgade 28 A
DK-1260

FLAGSHIP STORE

Bredgade 28 B
DK-1260

WEBSITE:

www.brdr-kruger.com